

SANSKAR BHARTI SCHOOL

Holiday Homework

Class: Play House

Student Name: _____

Dear Children,

Hurry! Finally the summer holidays are here. Holidays are great, but school home-work can be fun and inspiring too! So to keep you engaged and active, here are a few interesting activities for the summer break

Fun under the Sun

Beat the heat by learning to make tasty summer drinks like lemon juice, lassie, milk shake, fruit smoothies or sherbats (take help from your parents).



Fill Color

Q2. a) Join the dots and color it.

b) Learn Poems

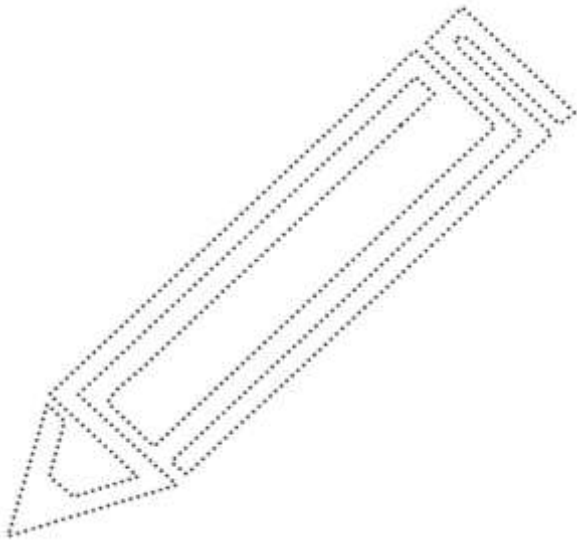

**Twinkle, twinkle, little star,
How I wonder, what you are!
Up above the world so high,
Like a diamond in the sky!**

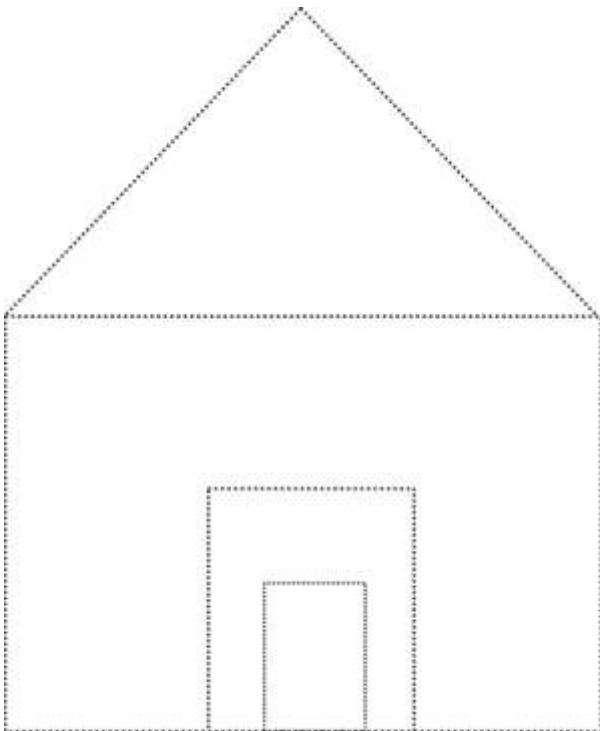

**One, Two, buckle my shoe.
Three, Four, knock at the door.
Five, Six, pick up sticks.
Seven, Eight, lay them straight.
Nine, Ten, a big fat hen.**

Q3. Join the dots to draw sleeping lines

Handwriting practice lines consisting of solid top and bottom lines with a dashed middle line for tracing.

Can you take them to their vehicles ?

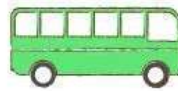

Q4. Join the dots to draw slanting lines.

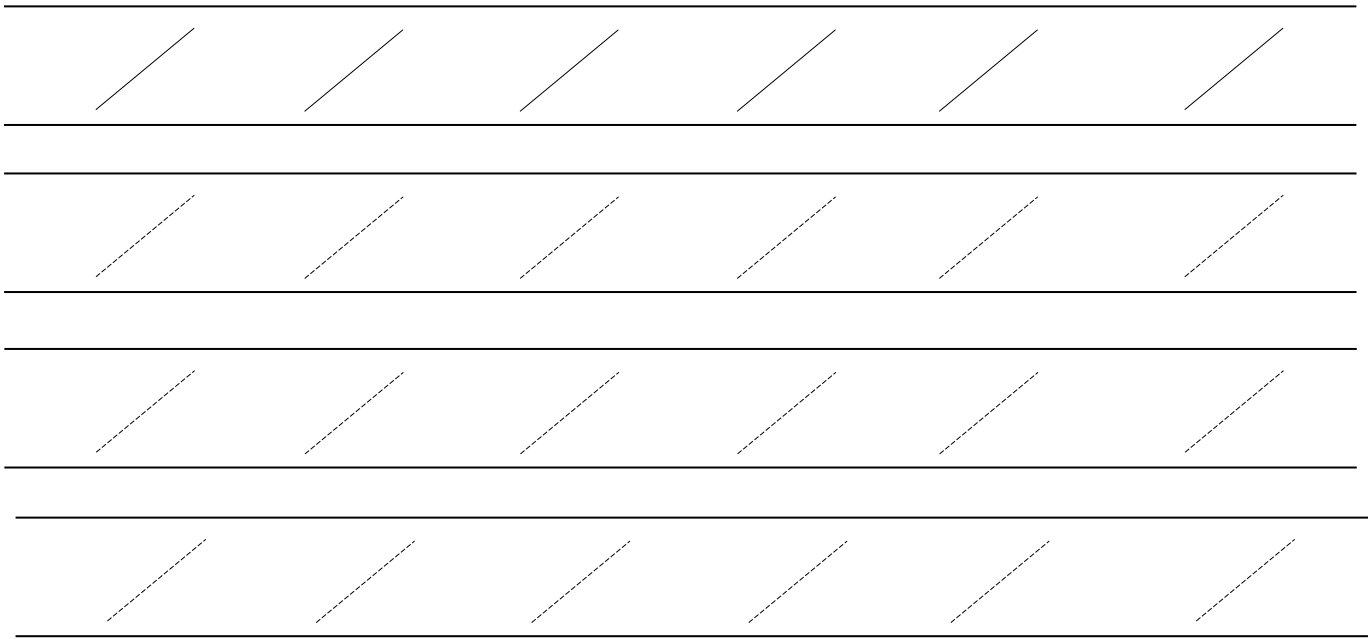

Draw slanting lines and Color it

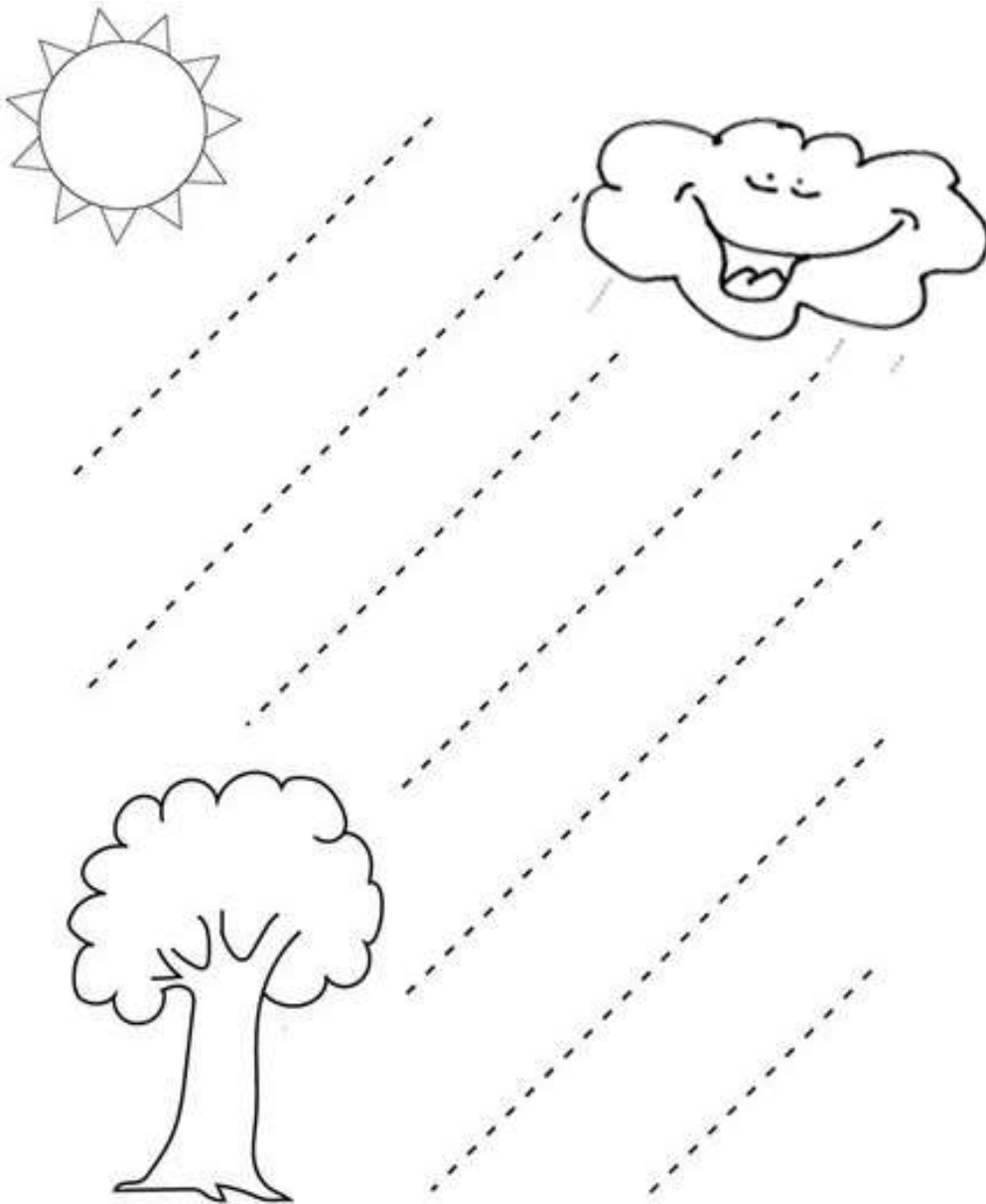

HINDI

Q5. बिन्दुओं को मिलाओ।

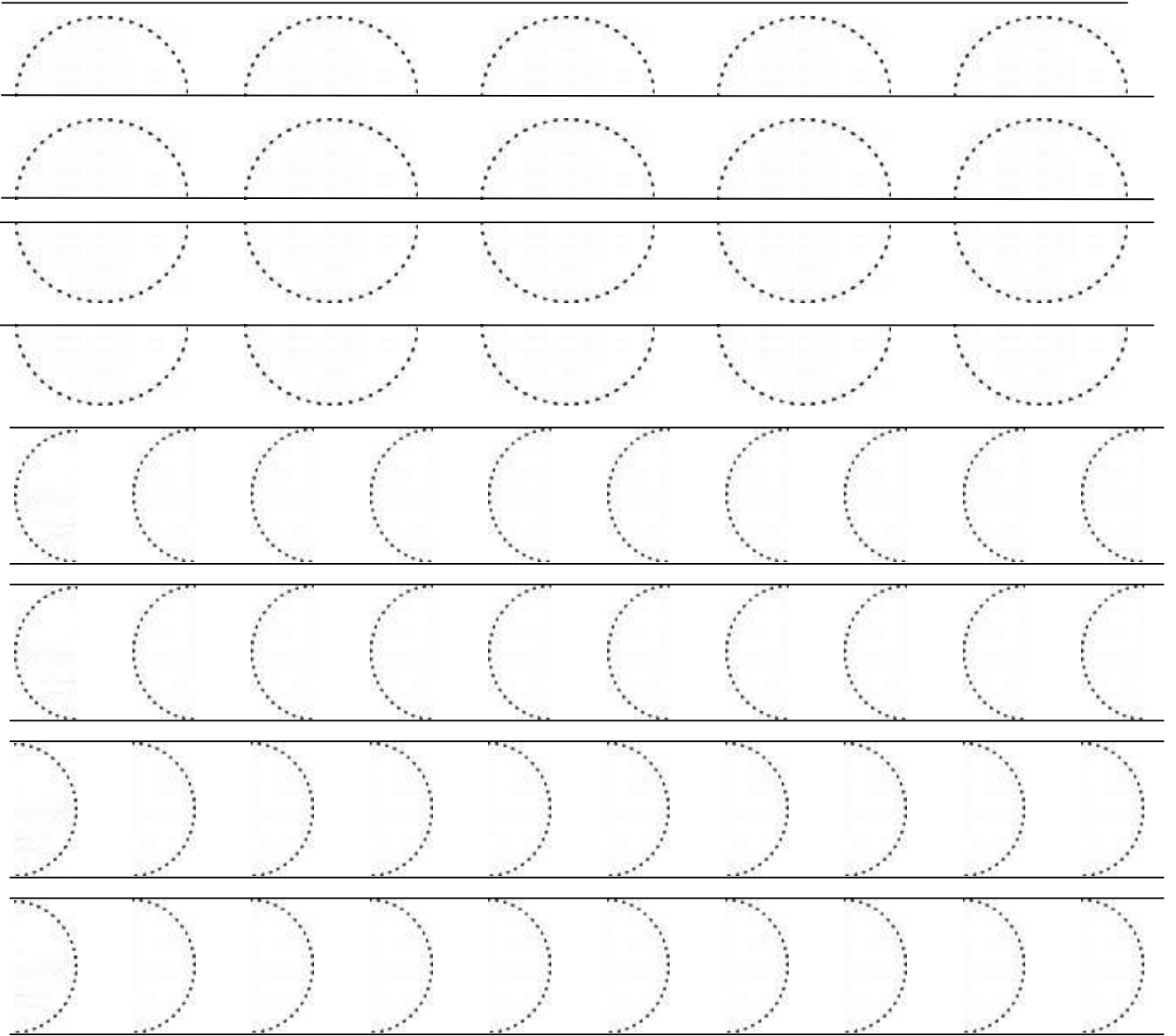

Q6. कविता याद करो- रंग भरो

तितली आई रंग-बिरंगी,
फूल सूँघती चंगी-मंगी।
नहीं पकड़ में आती है,
ये झटपट उड़ जाती है।

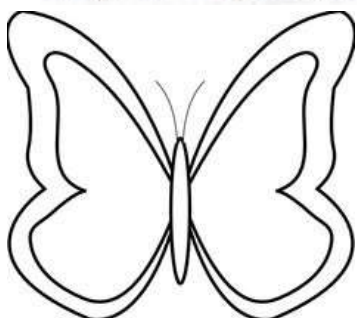

आई गर्मी, बहा पसीना,
मई जून का गर्म महीना।
पंखा तेज चला दो ना,
आइसक्रीम खिला दो ना।



DRAWING

